



AZEK Mouldings, manufactured using breakthrough technology, have the same look and feel to match all AZEK Trim products.

Using AZEK Trim and AZEK Moulding together provides a complete low maintenance trim option with lasting good looks.



AZEK Moulding

The best looking, highest performing wood replacement line of mouldings available in the market.

- > Breakthrough technology offers the same color, look, and feel as AZEK Trim.
- > Void free product offers greater stability and predictability when fastening and minimizes expansion/contraction.
- > No painting required, yet easy to paint if a custom color is desired.
- > UV protection inside and out.
- > Uniform material, same formula as AZEK Trim, to minimize chip outs on cut lengths.
- > One warranty covers all products.
- > No cupping, swelling, rotting, or splitting.
- > Use AZEK Adhesive, a proven adhesive for “welding” all AZEK products together, to glue seams so they will never open.
- > AZEK Mouldings are installed with the same tried and true installation methods as traditional wood mouldings.

- Standard AZEK Installation Guidelines will apply to AZEK Mouldings.
- Pay attention to proper fastening and gluing.

Crown Profiles

- > Crown moulding profiles are typically decorative mouldings designed for use along the inter section of a wall and ceiling.
- > May be combined with other mouldings to create a “built-up” profile.

6” Crown
AZM-45

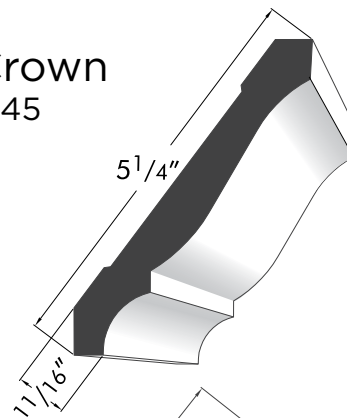

5” Crown
AZM-47

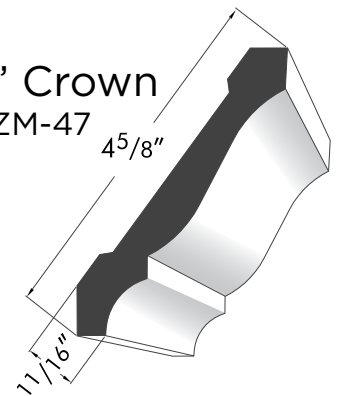

4” Crown
AZM-49

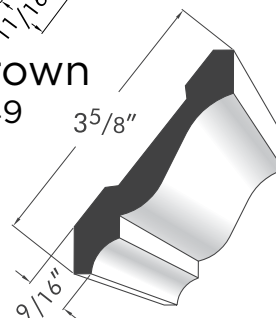

Rams Crown
AZM-6934

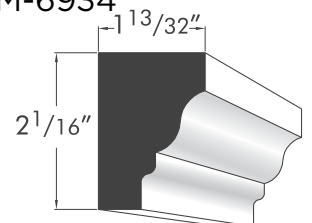

Casing Profiles

> Casing profiles are decorative mouldings typically used flush against a wall, door or window to create surrounds.

Base Cap
AZM-164

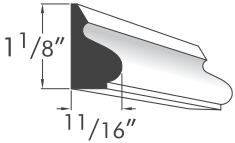

Back Band
AZM-6931

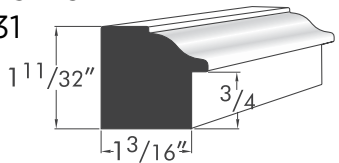

Brick Mould
AZM-180

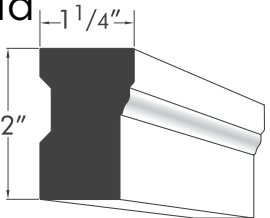

Rake Moulding
AZM-287

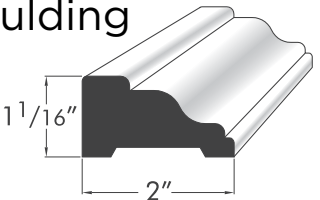

Adams Casing
AZM-97

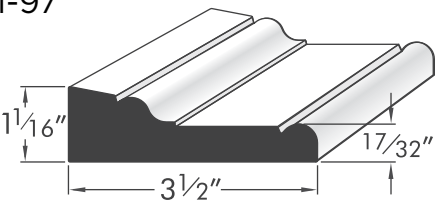

Drip Cap Profiles

> Drip Cap is typically used as a water table or brick ledge for separation and water shed against two differing material types.

Drip Cap
AZM-197

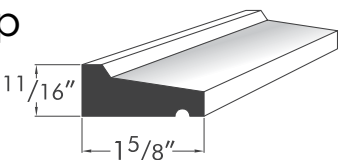

Cove Profiles

- > Cove profiles are typically used along the intersection of a wall and ceiling.
- > Also can be used as a base cap on a column.

Bed Moulding
AZM-75

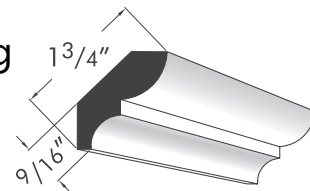

Scotia
AZM-93

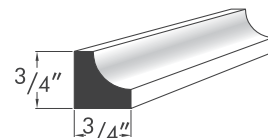

Quarter Round
AZM-105

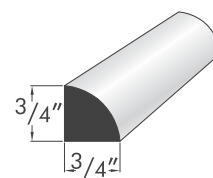

Sill Profiles

- > Sill profiles shed water and offer architectural detail.

Historic Sill
AZM-6930

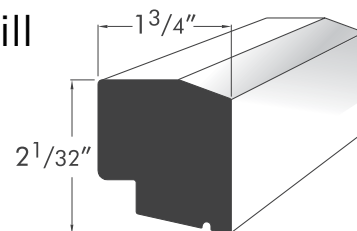

Sub Sill Nose
AZM-6933

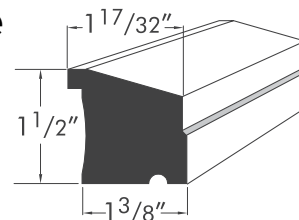

Shingle Band Profile

- > Shingle Band is designed for use as a window or door casing or as a decorative shoe base.

Shingle Mould
AZM-210

